

LINEAR CLOSED CEILING 75C-150C-225C

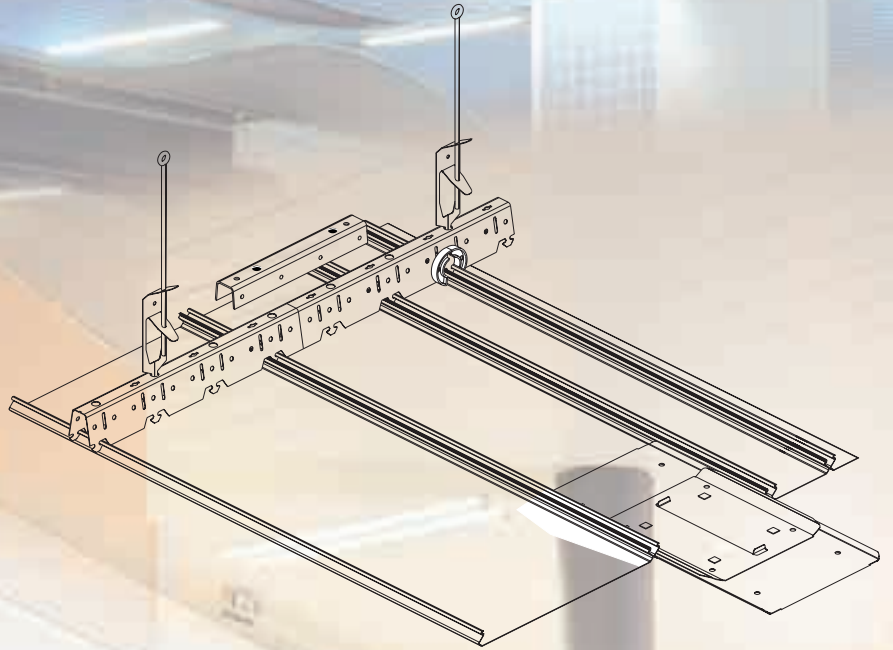

www.luxalon.com

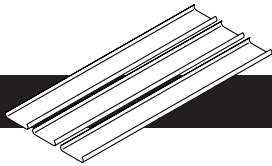



SHORT SYSTEM DESCRIPTION

The Luxalon® closed ceiling system combines three widths of panels which are distinguished from other Luxalon® systems by their bevelled edges, and when installed produces a closed smooth appearance. All three widths can be clipped to a universal carrier thus providing the designer with unlimited possibilities.

The panels are made from 0.5 and 0.6 mm aluminium and can be supplied in any length up to 6000 mm, the carriers are 5000 mm long as standard.

The panels are joined together using a panel splice whilst the carriers use the standard carrier connector.

Our standard range of edge profiles can be used at perimeters and panels cut in length to form perimeter infill should be additionally supported using the special adaptor clip as indicated in the system overview.

SYSTEM OVERVIEW 75-150-225C

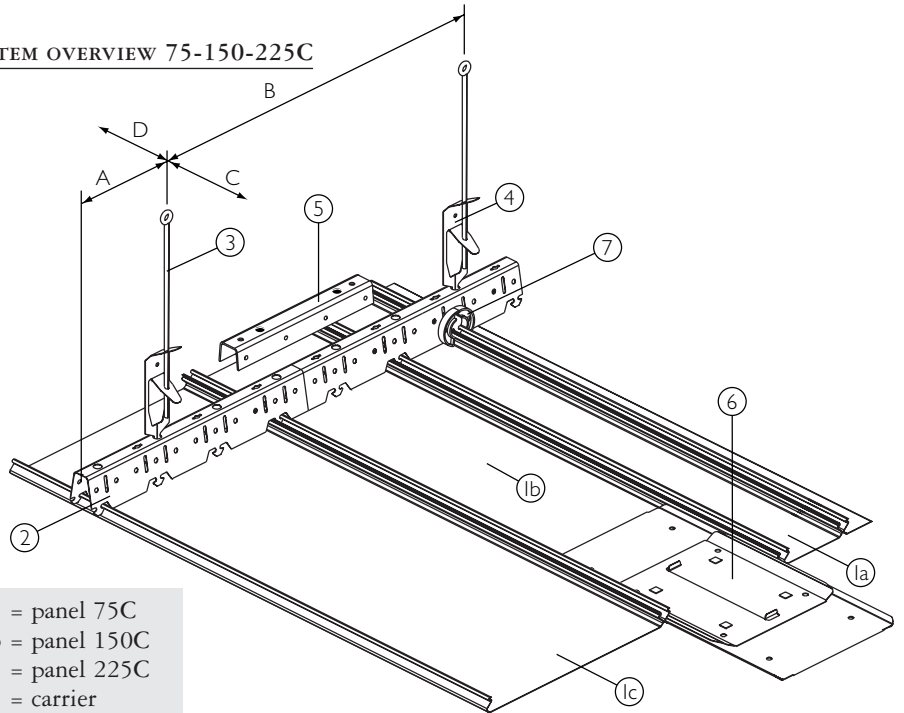

- 1a = panel 75C
- 1b = panel 150C
- 1c = panel 225C
- 2 = carrier
- 3 = rod hanger
- 4 = support clip
- 5 = carrier splice
- 6 = panel splice
- 7 = adaptor clip

PRACTICAL APPLICATIONS:

- Optimal acoustic control for office spaces, meeting rooms etc. can be achieved by using perforated panels with a non-woven textile membrane bonded to the inside face.
Alternatively: -sealed mineral wool pads can be overlaid.
- The absence of dust retention and ease of cleaning make the plain bevelled edge closed joint panels ideal for hospitals, kitchens, food preparation areas and anywhere where hygiene is important.
- Likewise, the neat closed joints present a smooth uninterrupted appearance for areas where elegant understatement harmonizes with the rest of the area.
- By combining the narrow and wide panels on one carrier, various dimensional effects are possible. These effects can be enhanced by incorporating colour from our extensive range.
- Each panel can be easily demounted by hand allowing full access to services and equipment in the plenum.
- Panels can be produced up to 6000mm long thus keeping the necessity for joints to a minimum.
- Panels are lightweight yet strong, made from aluminium which is fully recyclable.
- Panels can also be used for exterior application.

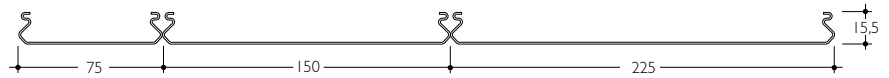

Panel type	Carrier span		Panel span	
	A	B	C	D
75C	300	1700	1250	150
150C	300	1700	1000	150
225C	300	1700	1000	150

Panel	Module	Material	Weight
15,5 x 75	75	0.5 Alu	2.13 kg
15,5 x 150	150	0.5 Alu	1.96 kg
15,5 x 225	225	0.6 Alu	2.19 kg

Weight kg/m²

STANDARD CONSTRUCTION DETAILS

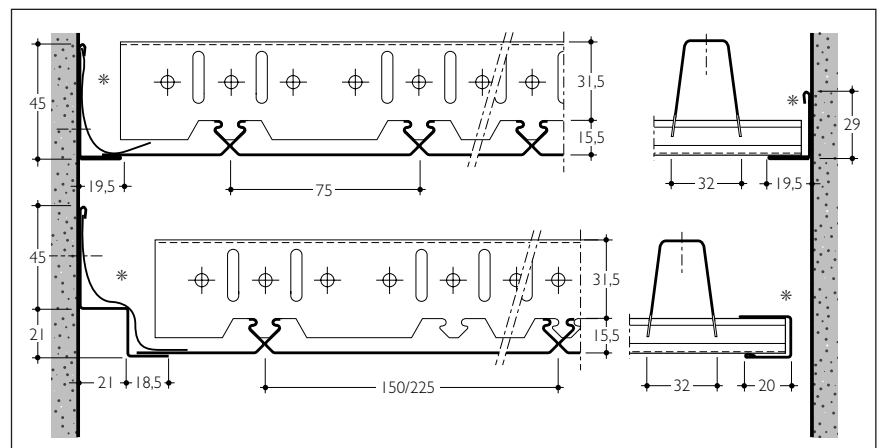

MATERIAL REQUIREMENTS PER M²

	Unit	75C	150C	225C
Panels	lm	13.33	6.67	4.44
Carriers	lm	0.80	1.0	1.0
Suspension	pcs	0.5	0.6	0.6

Edge profiles and other accessories depend on individual project requirements.

PLENUM ACCESSIBILITY

Although installed on a concealed carrier system, each individual panel can easily be demounted by clipping the edge of the panel from the prongs of the carrier, using e.g. a pallet knife.

EDGE PROFILES

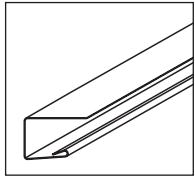

Clip-on U-profile alu
(28.6 x 19 x 20)

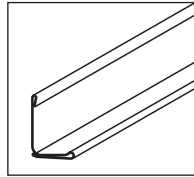

Wall L-profile alu
(29.2 x 19.4)

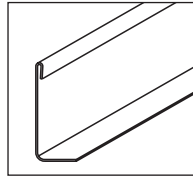

Wall L-profile Fe
(45 x 18.5)

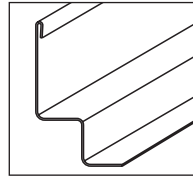

Wall W-profile Fe
(45 x 21 x 21 x 18.5)

ACOUSTIC PERFORMANCE

In order to improve interior sound control, the Luxalon® multi-panel closed ceiling panels can be perforated and also fitted with non-woven acoustic tissue.

PERFORATION OPTIONS:

	75C	150C	225C
• Ø 1,0 mm and Δ 2 mm with 23% open area	•	NA	NA
• Ø 1,5 mm and Δ 3 mm with 23% open area	NA	NA	•
• Ø 2,0 mm and Δ 5 mm with 16% open area	NA	•	•

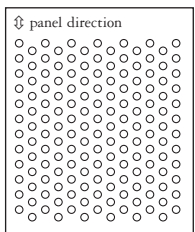

1 mm perf.
⇄ 2 ⇄ 3.46

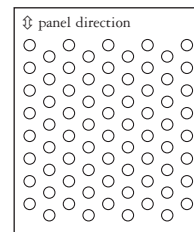

1.5 mm perf.
⇄ 3 ⇄ 5.2

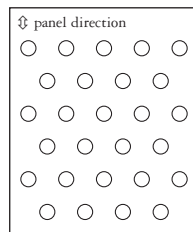

2 mm perf 150C
⇄ 8.66 ⇄ 5

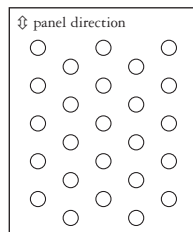

2 mm perf 225C
⇄ 5 ⇄ 8.66

SOUND ABSORPTION

CURVE 1 (75C):

75C panels with Ø1 mm holes. The reverse side of the panels is provided with black non-woven tissue glued over the whole perforated area. Plenum depth is 200 mm. The sound absorption curve has been taken from test report nr. 124.022 of TNO Delft.

CURVE 2 (150C/225C):

150C panels with Ø2 mm holes. The reverse side of the panels is provided with black non-woven tissue glued over the whole perforated area. Plenum depth is 200 mm. The sound absorption curve has been taken from test report nr. 124.022 of TNO Delft.

The sound absorption curve for 225C panels with Ø2 mm holes and non-woven tissue will resemble curve 2.

CURVE 3 (75C):

Perforated 75C panels with Ø1 mm holes. Between the carriers a 25 mm thick mineral wool pad with a density of approx. 22 kg/m³, plenum depth 200 mm. The sound absorption curve has been taken from test report no. 823.066 of TNO Delft.

CURVE 4 (225C):

300C panels with Ø1,5 mm holes. The reverse side of the panels is provided with black non-woven tissue glued over the whole perforated area. Plenum depth is 400 mm. The sound absorption curve has been taken from test report nr. TPD-HAG-RPT-94-0037 of TNO Delft.

The sound absorption curve for 225C panels with Ø1,5 mm holes and non-woven tissue will resemble curve 4.

MATERIAL SPECIFICATION

- BASE MATERIAL

Luxalon® multi-panel closed ceiling panels are produced from 0.5 or 0.6 mm thick pre-painted stove enamelled aluminium strip, alloy HD5050 or equivalent (according to EN 1396, and ECCA standards).

- COATING

The tough and durable 2-layer polyester coilcoating finish in a nominal thickness of 20 microns, is stove enamelled in a continuous coil-coating process ensuring uniform coating thickness and absolute adhesion.

- LUXALON® COLOUR RANGE

The standard Luxalon® colour range includes a large choice of colours and finishes. See Luxalon® colour chart. Any other (RAL or NCS) colour is available on request.

- FIRE BEHAVIOUR

Luxalon® metal suspended ceilings are classified incombustible and will therefore not contribute to possible fires. When ceilings however need to protect the structural integrity of a building, Luxalon® ceilings offer a range of practical and tested solutions with regards to fire resistance and fire stability. Further information is available on request.

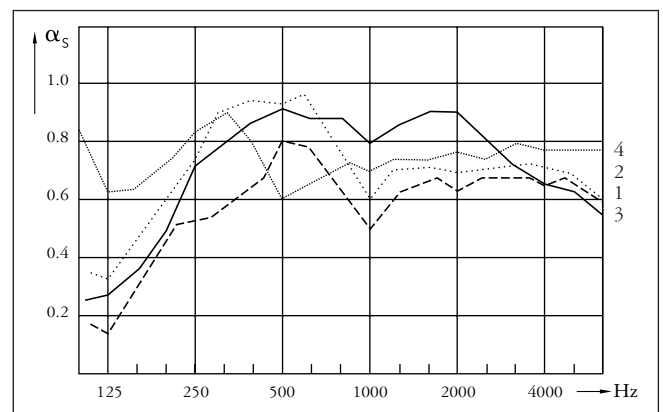

Freq. Hz.	125	250	500	1000	2000	4000
Curve 1 (75C)	0.17	0.52	0.81	0.49	0.65	0.66
Curve 2 (150C/225C)	0.30	0.74	0.88	0.58	0.71	0.70
Curve 3 (75C)	0.30	0.70	0.90	0.80	0.90	0.65
Curve 4 (225C)	0.62	0.82	0.60	0.70	0.78	0.77

LUXALON® CLOSED CEILING 75/150/225C SPECIFICATION

PART 1. GENERAL

1.1 INTRODUCTION

Supply and fix Luxalon® Closed Ceiling System as manufactured by Hunter Douglas Architectural Products

1.2 DESCRIPTION OF THE SYSTEM

The system will consist of longitudinal panels clipped on to the carriers. The panels abut each other with a narrow V-groove. Panels of different widths can be combined as required in the ceiling.

PART 2. PRODUCT

_____ m² Luxalon® Multi-panel Closed Ceiling, consisting of:

2.1 PANELS:

75C, manufactured from 0.5 mm Al, size 75 x 15,5 mm
150C, manufactured from 0.5 mm Al, size 150 x 15,5 mm
225C, manufactured from 0.6 mm Al, size 225 x 15,5 mm

Panels to be manufactured from prepainted, stove enameled, alloy HD5050 or equal (according to EN 1396 and ECCA).

All panels to be securely clipped to carriers in accordance with manufacturers recommendations. Panels to be joined in length by using the relevant Luxalon® splice. Maximum panel length to be 6000 mm.

2.2 SUSPENSION

Rows of 0.5 Fe/0.95 Alu rollformed carriers shall be installed at ___/___/___ centers by means of _____ mm rod hangers fixed to the carrier by means of Luxalon® universal suspension adjustment clips at a max. distance of ___/___/___ mm, center to center. Carriers with a max. length of 5000 mm to be coupled by means of carrier splices, automatically arranging for module continuation.

2.3 EXTERIOR APPLICATION

The Luxalon® Closed Ceiling System can also be used for exterior applications. For specification details concerning exterior applications contact your local Hunter Douglas office.

PART 3. ADDITIONAL SPECIFICATIONS

3.1 PERIMETER PROFILES

- Clip-on U-profile, 28.6 x 19x20 mm, made of 0.35 mm thick aluminum
- Wall L-profile, 29.2 x 19.4 mm, made of 0.5 mm thick aluminum
- Wall L-profile, 45 x 18.5 mm, made of 0.8 mm thick steel
- Wall W-profile, 45 x 21 x 21 x 18.5 mm, made of 0.8 mm steel

3.2 PERFORATIONS

Manufacturer shall supply panels with following perforation specifications:

- 75C : Ø 1.0 mm, Δ 2 mm, open area 23%
 - 150C : Ø 2.0 mm*, Δ 5 mm, open area 16%
 - 225C : Ø 1.5 mm, Δ 3 mm, open area 23%
 - 225C : Ø 2.0 mm*, Δ 5 mm, open area 16%
- * Ø 2 mm perforation pattern of 150/225C shows an optical difference.

Perforated 150/225C panels have a nominal plain border of approximately 9 mm on the side for optimal flatness and stability. For 75C panels the plain border is 3 mm.

3.3 ACOUSTICS

Manufacturer shall supply acoustic non-woven tissue factory applied inside the panels or alternatively the installer can place individual wrapped mineral wool pads to the back of the installed ceiling panels.

3.4 COATING

Architect will make a colour selection from the standard Hunter Douglas colour range for Luxalon® 75/150/225C panels code no. _____ or a special colour will be made to match _____.

The coating will consist of a tough and durable 2-layer polyester coilcoating finish in thickness of 20 microns, applied in a continuous coil-coating process ensuring uniform coating and absolute adhesion.

3.5 INSTALLATION

All materials shall be installed in strict compliance with all local codes, ordinances and manufacturers recommendations including specific additional requirements as may be called for in the specifications or shown on the drawings.

3.6 SUBSTITUTIONS

Ceiling installers wishing to submit proposals on systems other than the Luxalon® Closed Ceiling System shall, at least 10 days in advance of the bid date, submit to the architect complete descriptive information of the total system concept and performance data tests made as a system. In addition include a list of similar installations of the proposed substitution. If approval is made an addendum will be issued enumerating such approved system as herein set forth.

LUXALON® CEILING SYSTEMS

Unit 7 & 8 Keys Business Park - Keys Park Road - Hednesford - WS12 5GW

Tel. (01543) 273620 - Fax (01543) 270084 - e-mail: luxalon-ceilings@hunter-douglas.co.uk - www.luxalon.com

©Registered trademark - a HunterDouglas® product Pats. & Pats. Pend. - Technical data subject to change without notice. MX201Q00
©Copyright HunterDouglas® 2003. No rights can be derived from copy, text pertaining to illustrations or samples. Subject to changes in materials, parts, compositions, designs, versions, colours etc., even without notice.

LUXALON®
ARCHITECTURAL PRODUCTS

